

## LIT-37100









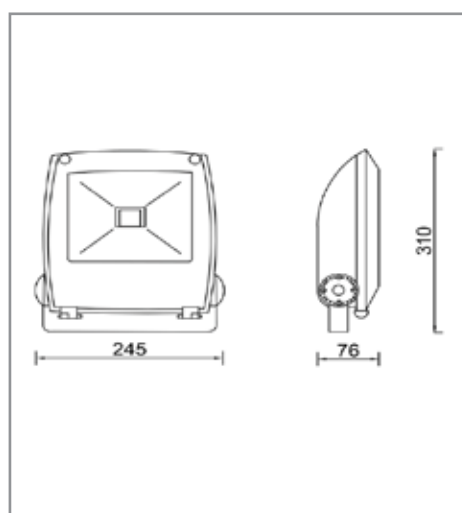

Range of high-performance floodlights using high efficiency LED chip with high thermal conductivity, low luminous decay and pure light color. High-pressure die-cast Aluminium body & cover with polyester powder coating after phospho-chromatation treatment with high-purity aluminum reflector.

**APPLICATIONS**

Facade lighting, sports lighting, general outdoor lighting, etc...



       	
<b>LUMEN, MAINTENANCE &amp; FAILURE RATE</b>	L90/B10 80,000 hrs
<b>DIMENSION</b>	310 X 245 X 76 mm
<b>COLORS</b>	Grey
<b>DIFFUSER</b>	Tempered Glass
<b>POWER SUPPLY</b>	Electronic Driver
<b>REPLACE MODEL</b>	LIT-FLOOD 75

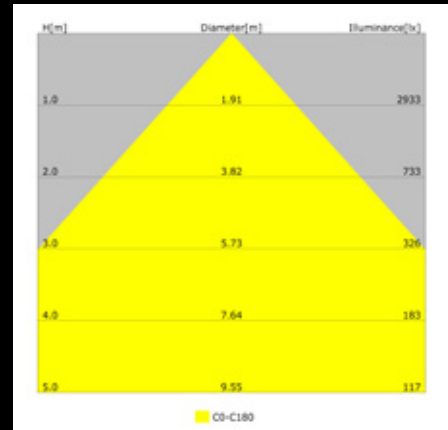

4525168

CODE	LED LUMEN	LUMINAIRE LUMEN	EFFICIENCY	LED WATTAGE	COLOR TEMPERATURE	BEAM ANGEL
4525167	7383lm	5782lm	116.3lm/w	49.7W	3000K	Wide Beam
CODE	LED LUMEN	LUMINAIRE LUMEN	EFFICIENCY	LED WATTAGE	COLOR TEMPERATURE	BEAM ANGEL
4525168	7774lm	6087lm	122.5lm/w	49.7W	4000K	Wide Beam



