

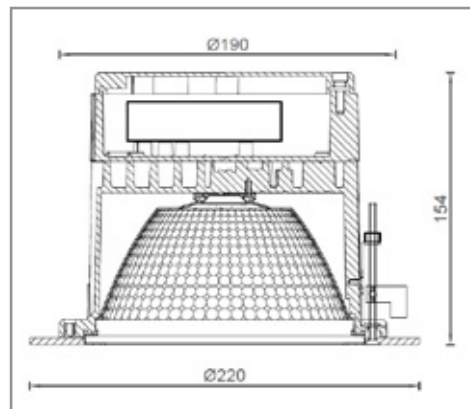





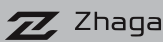

LIT-46100

Recessed mounted downlight.
Made of Die-cast aluminum
body, Stainless Steel frame,
aluminum reflector and clear
glass diffuser.

APPLICATIONS

Hotels, Banks, Hospitals and
Shopping centers.



       	
LUMEN, MAINTENANCE & FAILURE RATE	L90/B10 >70,000 hrs
BODY MATERIAL	Die-cast Aluminium body with Stainless Steel frame
REFLECTOR	High purity Aluminium
DIMENSION	H: 154mm, D:220mm
COLORS	Stainless Steel
DIFFUSER	Clear glass
POWER SUPPLY	Electronic Driver

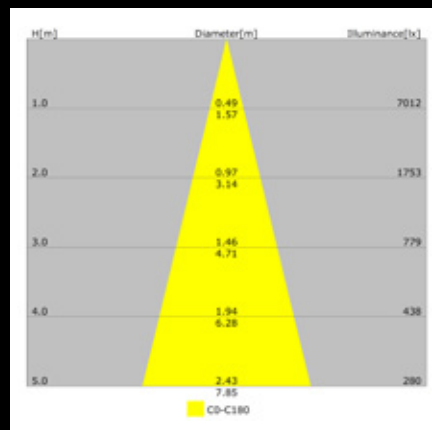

4023024

CODE	LED LUMEN	LUMINAIRE LUMEN	EFFICIENCY	LED WATTAGE	COLOR TEMPERATURE	BEAM ANGEL
4023024	1724lm	1050lm	80.7lm/w	13.0W	3000K	27°
4024024	2700lm	1645lm	94.0lm/w	17.5W	3000K	27°
4027024	3143lm	1915lm	89.9lm/w	21.3W	3000K	27°
4025024	3588lm	2185lm	86.3lm/w	25.3W	3000K	27°
4026024	4617lm	2812lm	88.4lm/w	31.8W	3000K	27°

CODE	LED LUMEN	LUMINAIRE LUMEN	EFFICIENCY	LED WATTAGE	COLOR TEMPERATURE	BEAM ANGEL
4023025	1819lm	1108lm	85.2lm/w	13.0W	4000K	27°
4024025	2851lm	1736lm	99.2lm/w	17.5W	4000K	27°
4027025	3318lm	2020lm	94.8lm/w	21.3W	4000K	27°
4025025	3788lm	2307lm	91.1lm/w	25.3W	4000K	27°
4026025	4848lm	2953lm	92.8lm/w	31.8W	4000K	27°