

LIT-9100

LED strip light suitable for use in several projects. Easily bendable with a body of high quality material. IP65, resistant to mechanical factors and adverse external conditions.

LIT-9100 | LED Strip

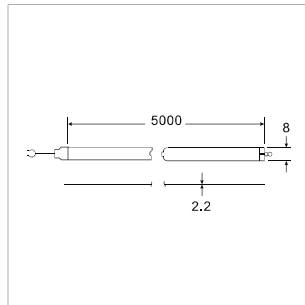
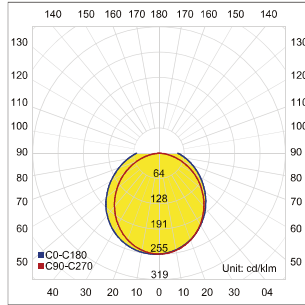

Lumen, maintenance & failure rate	L80/B50 >50,000 hrs
Body material	Silicon tube
Dimension	5000 x 8 x 2.2mm
Diffuser	Silicon tube
Power supply	24V DC

Customizable on request

*Longer lead time

Code	Strip Lumen	Efficiency	LED Wattage	Color Temperature	Voltage
0861355	300lm/m	62.5lm/w	4.8w/m	Warm	24V
0863355	900lm/m	62.5lm/w	14.4w/m	Warm	24V
0864355	1300lm/m	67.7lm/w	19.2w/m	Warm	24V
0861375	300lm/m	62.5lm/w	4.8w/m	Cool	24V
0863375	900lm/m	62.5lm/w	14.4w/m	Cool	24V
0864375	1300lm/m	67.7lm/w	19.2w/m	Cool	24V



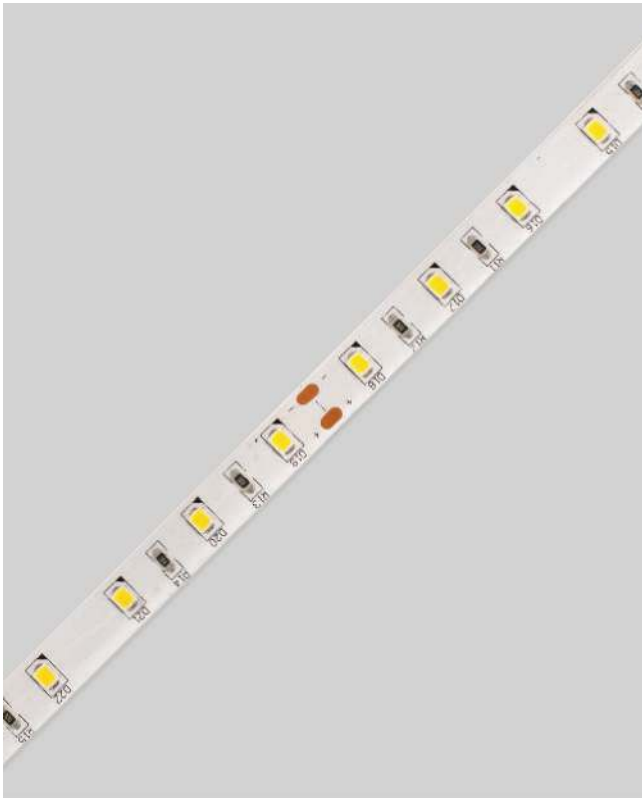

LIT-9100 | LED Strip



Lumen, maintenance & failure rate	L80/B50 >50,000 hrs
Body material	Flexibel PCB
Dimension	5000 x 8 x 2.2mm
Power supply	24V DC

Customizable on request



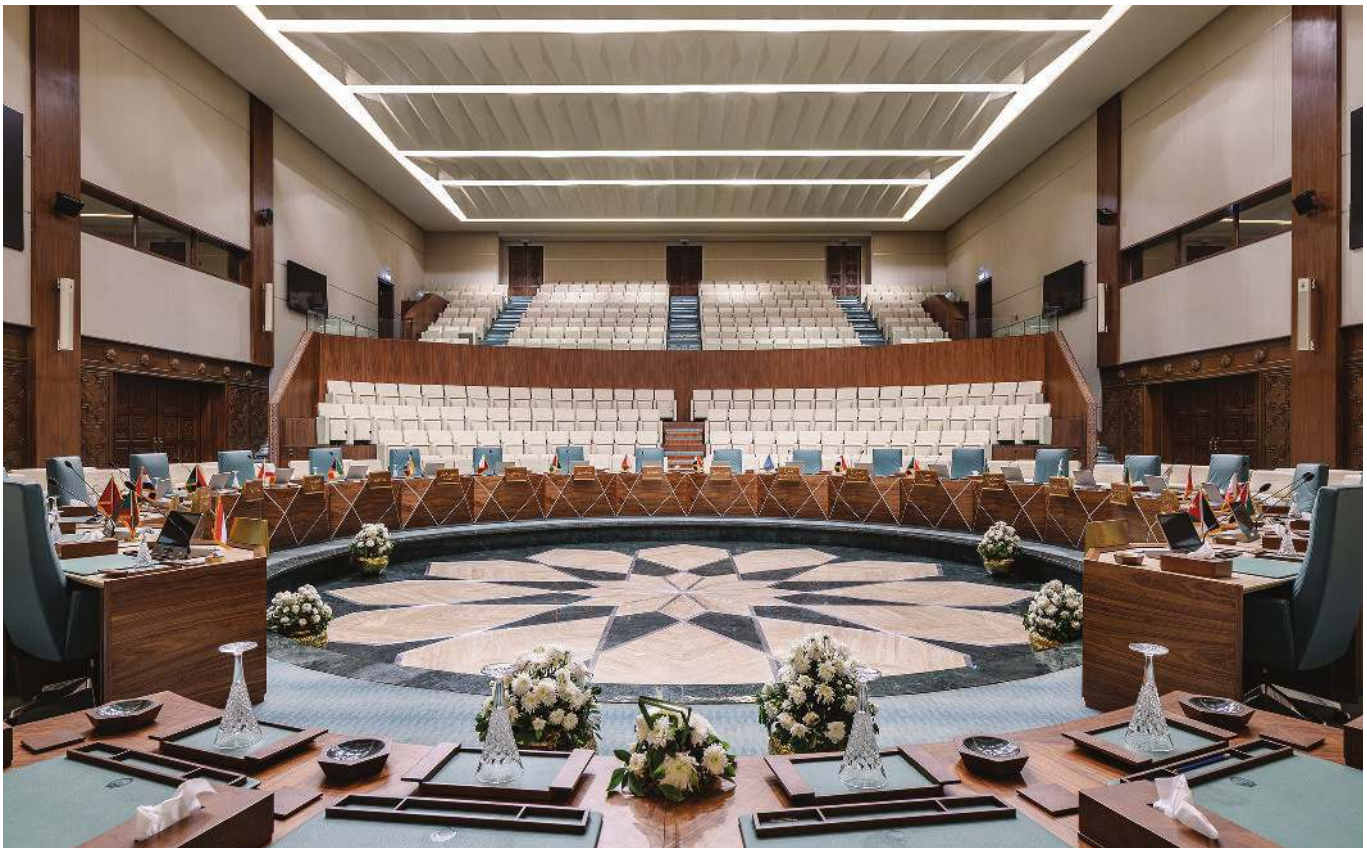

*Longer lead time

Code	Strip Lumen	Efficiency	LED Wattage	Color Temperature	Voltage
0861155	300lm/m	62.5lm/w	4.8w/m	Warm	24V
0864155	1300lm/m	67.7lm/w	19.2w/m	Warm	24V





Accessories

Code	Description	
0851102	Linear aluminum profile	
0852302	Linear cover	
0853301	Linear end cap	

Code	Description	
0854101	Asymmetrical aluminum profile	
0855103	Asymmetrical "L" connector	

Code	Description	
0854102	Incline aluminum profile	
0855110	Incline cover	
0855102	Incline end cap	

Code	Description	
0851104	Linear flate profile	
0852303	Linear flate diffuser	

Code	Description	
0851104	Linear flate profile	
0852304	Linear square diffuser	



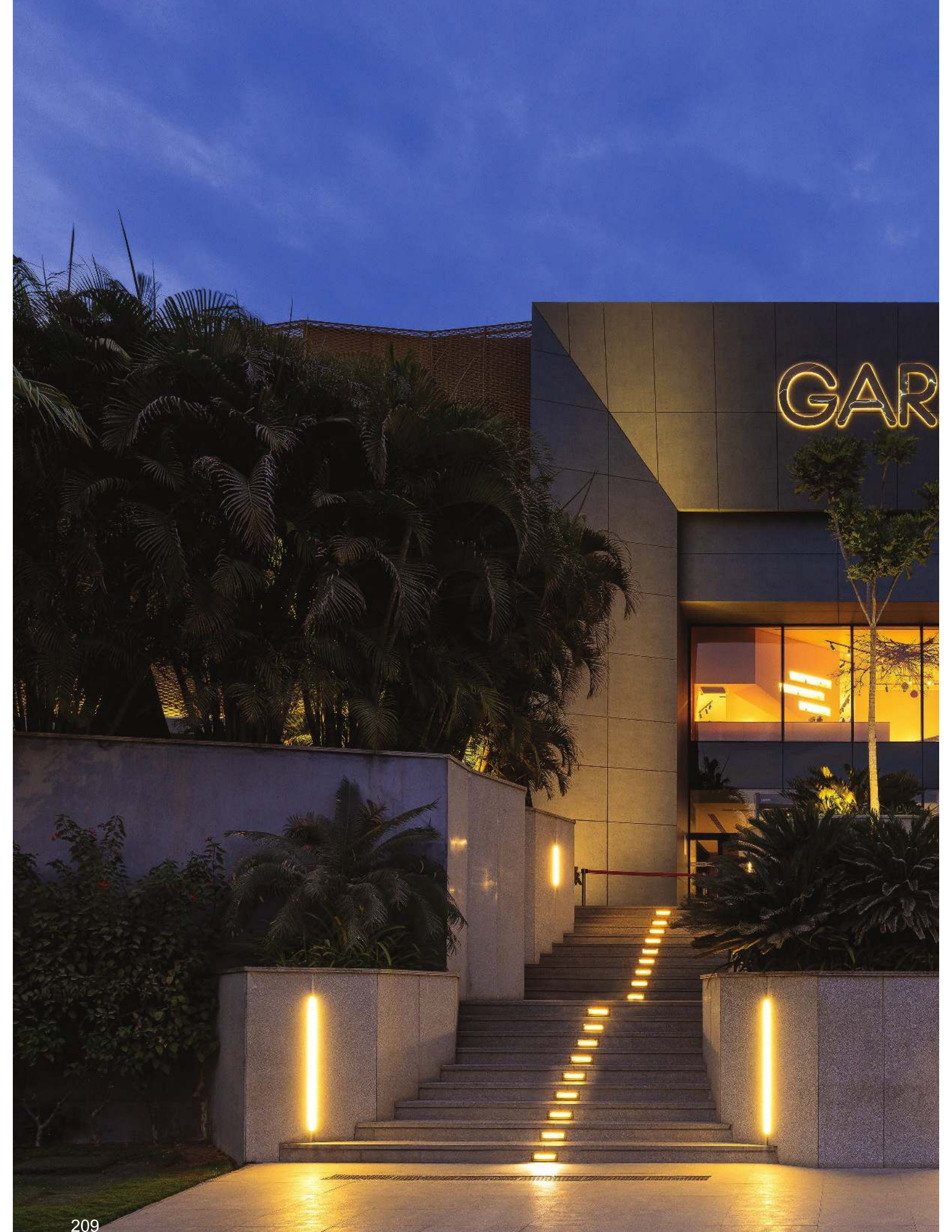

GAR

